

Autoclave

고압멸균기

Features

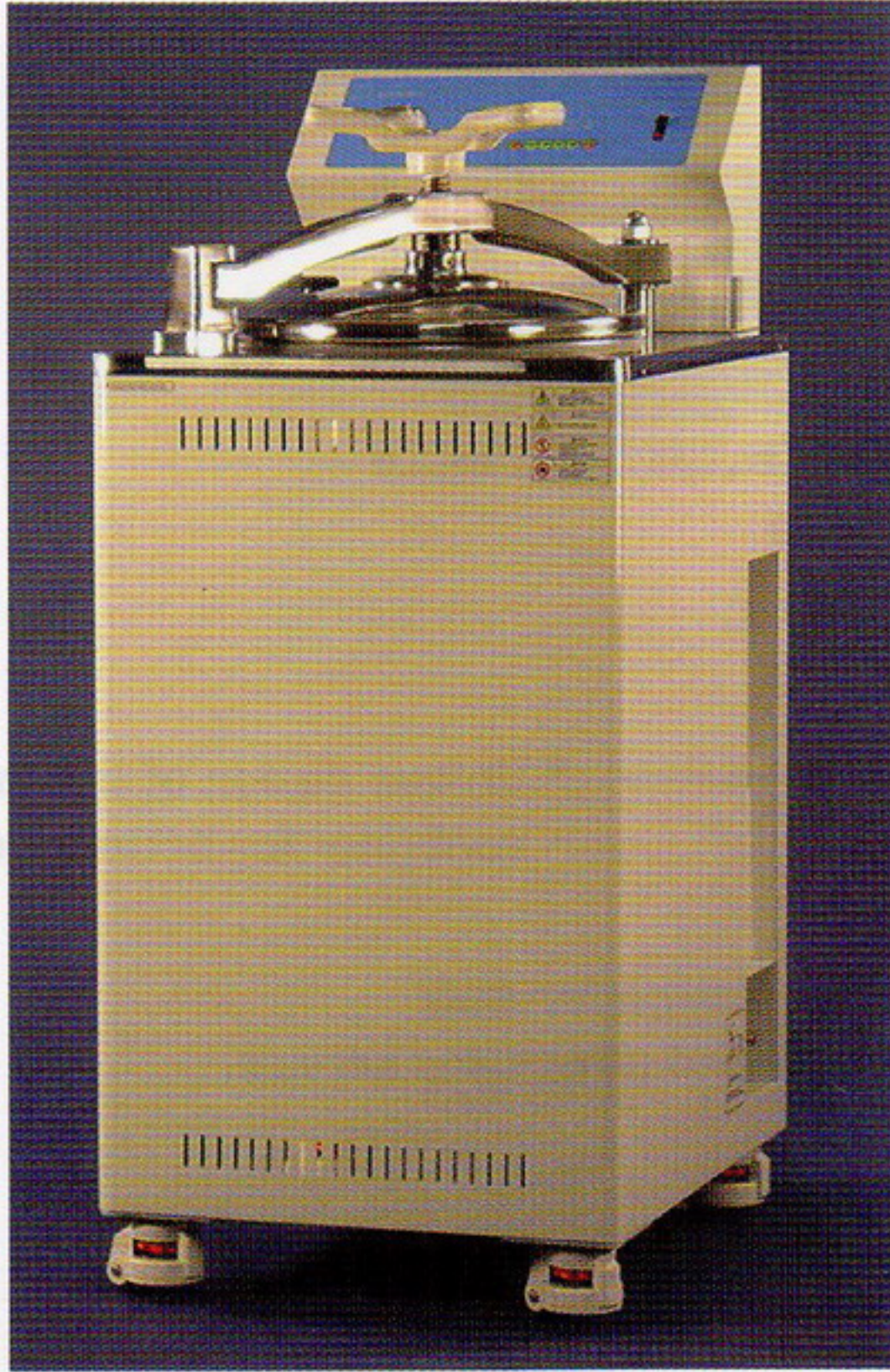

- * Fuzzy function to prevent overheat.
- * Accurate temperature controls by Digital PID controller.
- * In case of difference between real temperature and appeared temperature, user can adjust correctly.
- * When controller setting value is changed by the mistake of operation, save and recall function can restore it easily.
- * After setting the temperature and time, just press the start button, then the automatic process occurs. The air inside is discharged. Sterilizing temperature is reached after sterilizing period. The steam and air pressure are eliminated. And the buzzer sounds at the end.
- * Stable standing during opening and closing the cover by use of the parking casters.
- * Steam exit and valve placed in buried area not to expose outside.
- * STS #304 used in inside chamber for durability.
- * For user safety auto and manual safety valve installed.
- * Buffering device to enhance door adherence for insulation.
- * Upper vent to emit moist and gas of samples after evaporation.
- * Circuit breaker for electrical safety

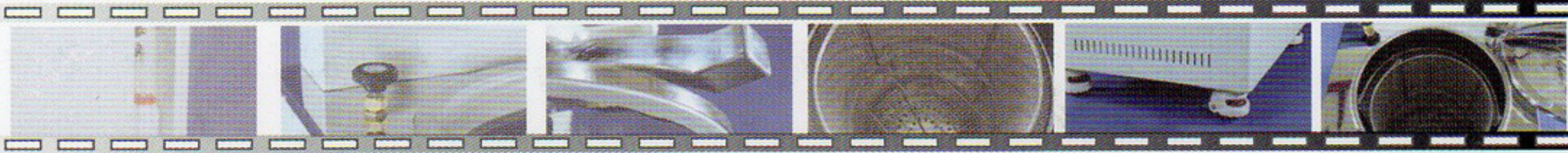

Specifications

Spec. / Model	AC-45	AC-60	AC-80	AC-100
Capacity	45ℓ	60ℓ	80ℓ	100ℓ
Temp	Range Max 125 ° C			
	Controller Digital PID auto-tuning controller			
	Sensor Pt100			
Pressure	1.5kg /cm ²			
Outsize(WxDxH,mm)	505x605x985	505x605x1130	560x650x1100	600x710x1200
Material	External Steel, Powder coating			
	Basket Wire Mesh type 2ea			
Electric Requirements	220VAC / 60Hz			
WATT	2300W	2300W	3000W	4600W

Autoclave

고압멸균기

Distinction

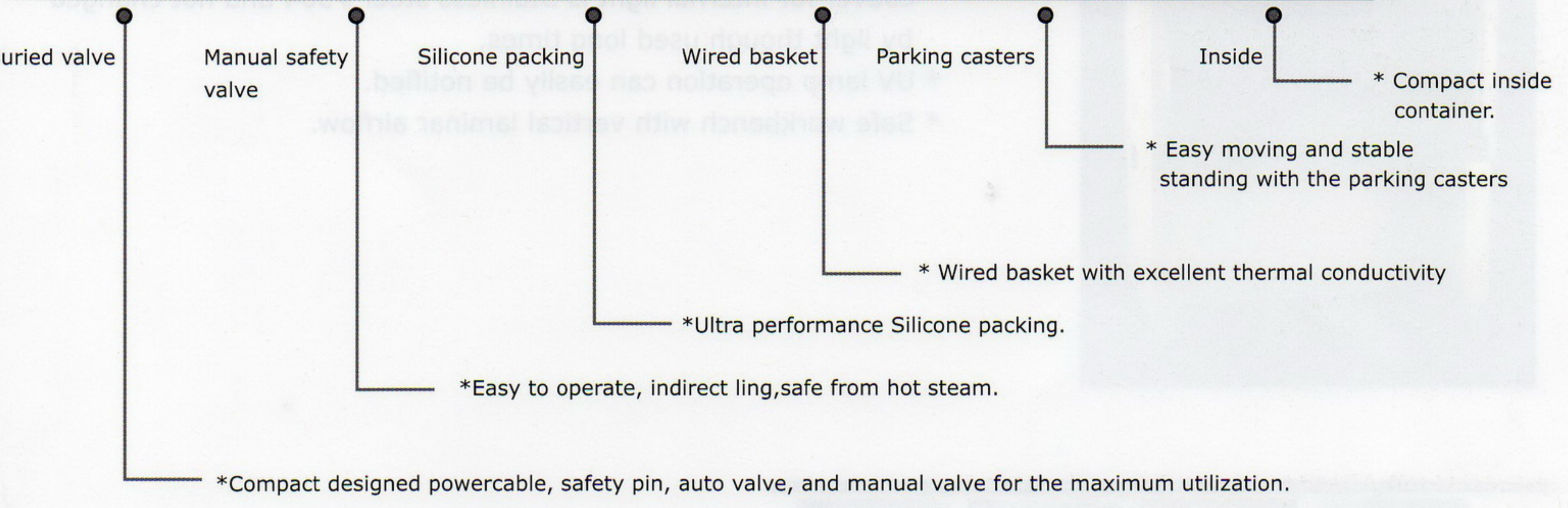
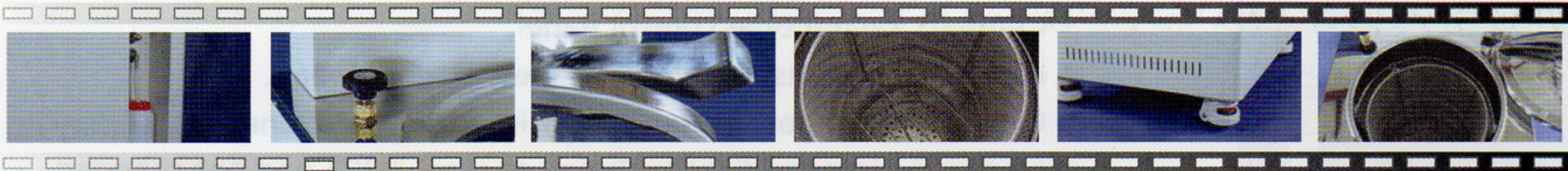

Structure

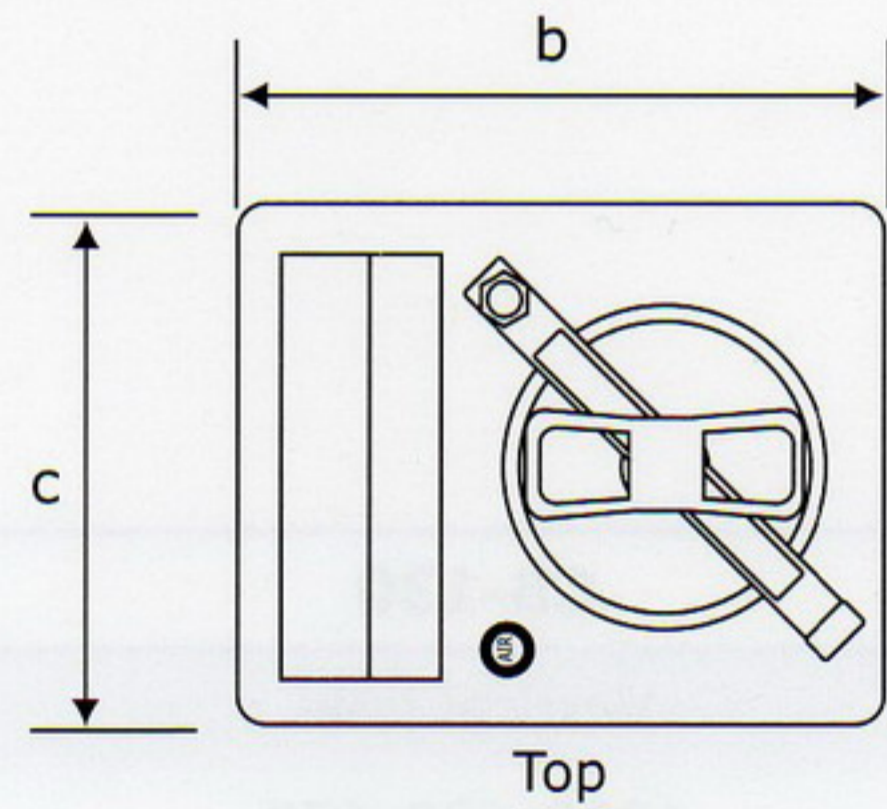

Dim	Φa	b	c	d	e	f	g	h	i
	Φ350	600	500	1030	434	780	520	117	250

(mm)

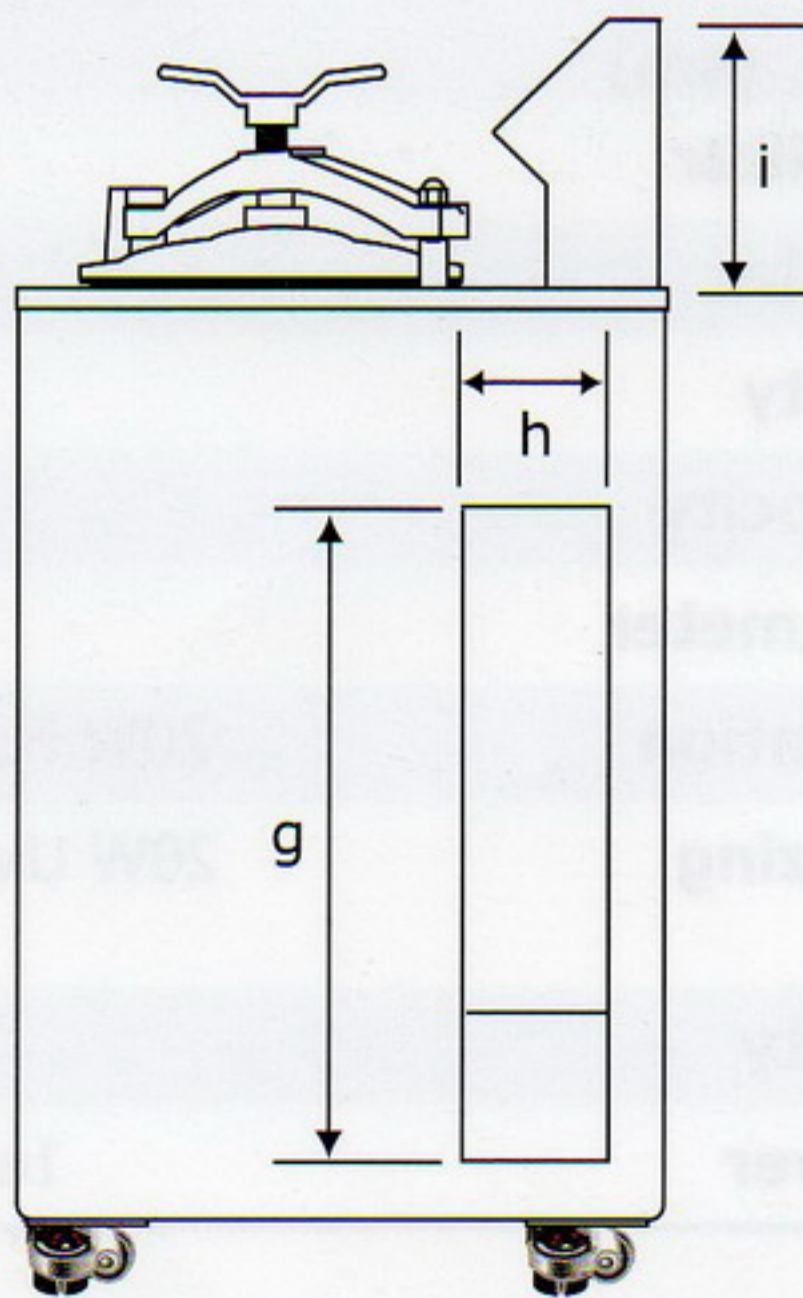
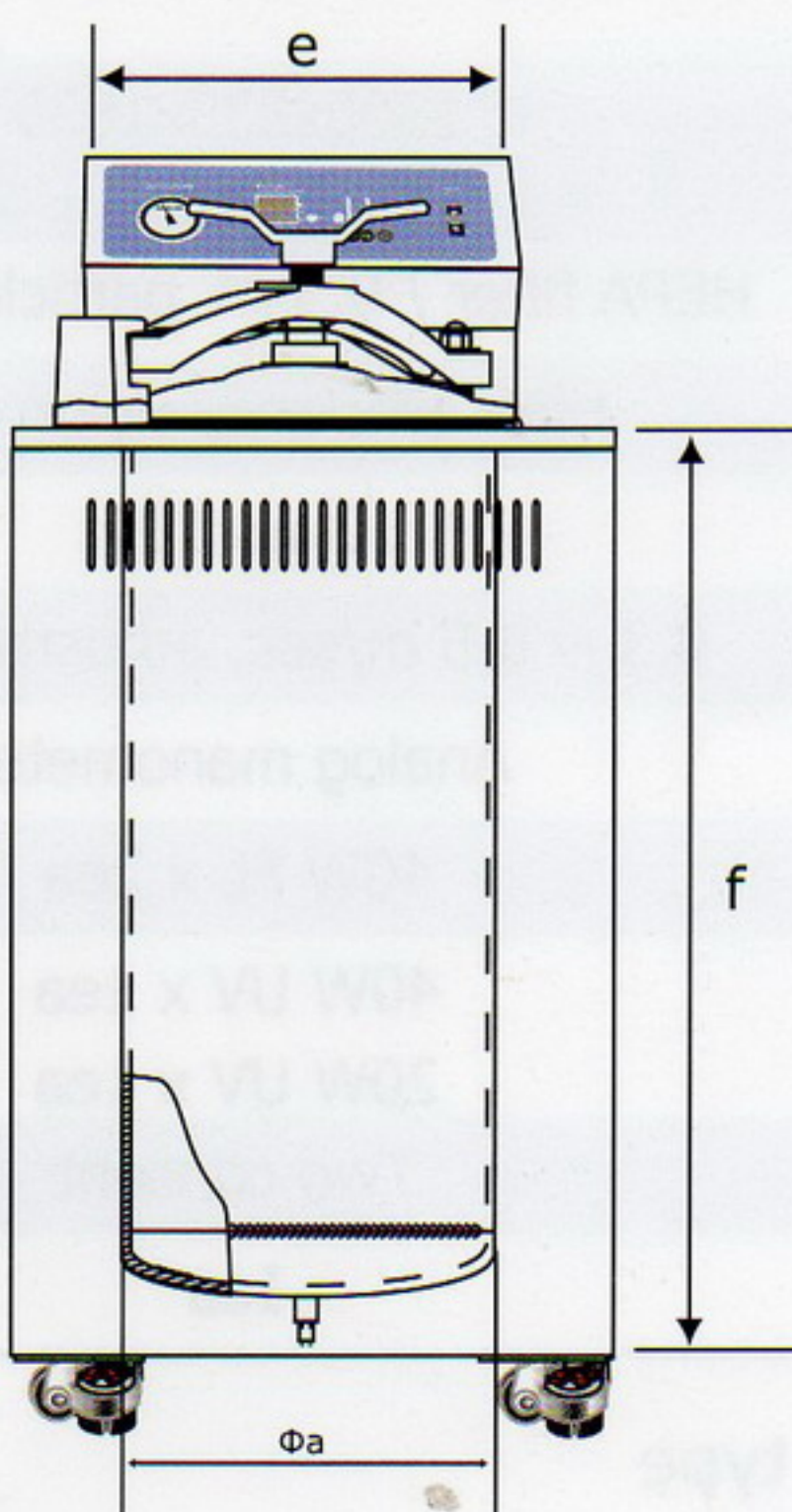
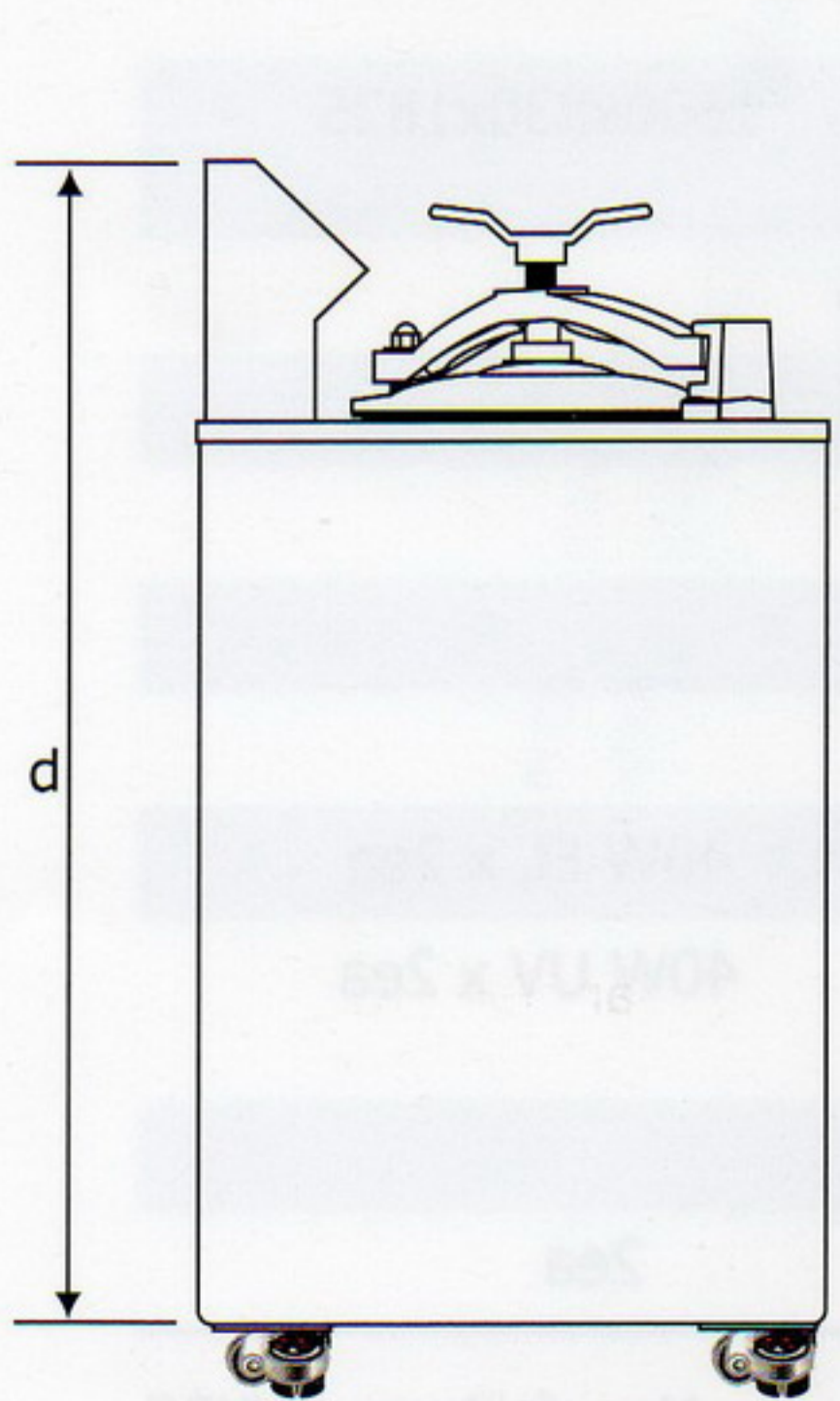

Left

Front

Right